

ARD-1-32-TP-R-SPD Installation Manual

V1.10 Jan 2023



Contents

Product Description	3
Warning Notice	3
Safety Advice	3
Introduction	4
Dimensions	5
Fixing Positions	6
Electrical Connections	7
Installation instructions	8
Operating Instructions	9
Test Function	10
SPD Operation	10
Specifications	11
Warranty	11
Declaration of Conformity	12

PRODUCT ADVISORY NOTICE

This product must be installed by a competent person in accordance with the IET Wiring Regulations, BS7671 (18th Edition or later) and current Building Regulations.

Ensure the electrical supply is disconnected before installation or removing the cover of the unit.

Product Description

The **matt:e** Electric Vehicle Charger Connection Units are designed for use in commercial applications where 3 phase PME supplies are feeding Electric Vehicle Chargers.

This manual covers the ARD-1-32-TP-R-SPD unit.

The unit is not intended for any purpose other than that defined within this document.

WARNINGS

Please read and observe the following notices carefully. These warnings must be observed when installing and operating the Electric Vehicle Charger Connection Units.

All relevant supplies must be isolated or disconnected before commencing any work. This product must be installed by a competent person in accordance with the IET Wiring Regulations, BS7671 (18th Edition or later) and any relevant Building Regulations and/or Installation Regulations.



**Electrical
hazard**

Once installed, the unit has a Live Mains Supply (400v or higher) within the enclosure. The cover must not be removed until the supply to the unit has been isolated or disconnected.

Safety Advice

The unit must be installed in a dry ventilated location; it must never be covered or have restricted ventilation.

The ARD-1-32-TP-R-SPD units are rated for a maximum load of 32A per phase.

For any information not contained within this document, please contact our technical support team on 01543 227290 or info@matt-e.co.uk.

Introduction

The **matt:e** range of Electric Vehicle Charger Connection Units are fitted with O-PEN® technology designed to protect Electric Vehicle Charging equipment when installed onto 3 phase PME infrastructures.

The unit incorporates a 5-pole isolator with a built-in under-voltage release mechanism. On detection of fault conditions, the O-PEN® electronic circuit de-energises the under-voltage release mechanism which disconnects all poles of the supply including CPC.

The 5-pole isolator will automatically reset after a PEN fault, but must be manually reset after an overcurrent fault in line with IET Wiring Regulations and code of practice.

The **matt:e** O-PEN® technology does not require earth rods or measuring electrodes to function correctly.

The units are designed to be installed indoors between the distribution board and the Electric Vehicle Charger. The unit must be mounted securely to a solid surface with the lid hinges on the left.

The installation location should be clean, dry and well ventilated.

Please refer to the diagrams on the following pages for the dimensions and mounting arrangement of the unit.

Dimensions

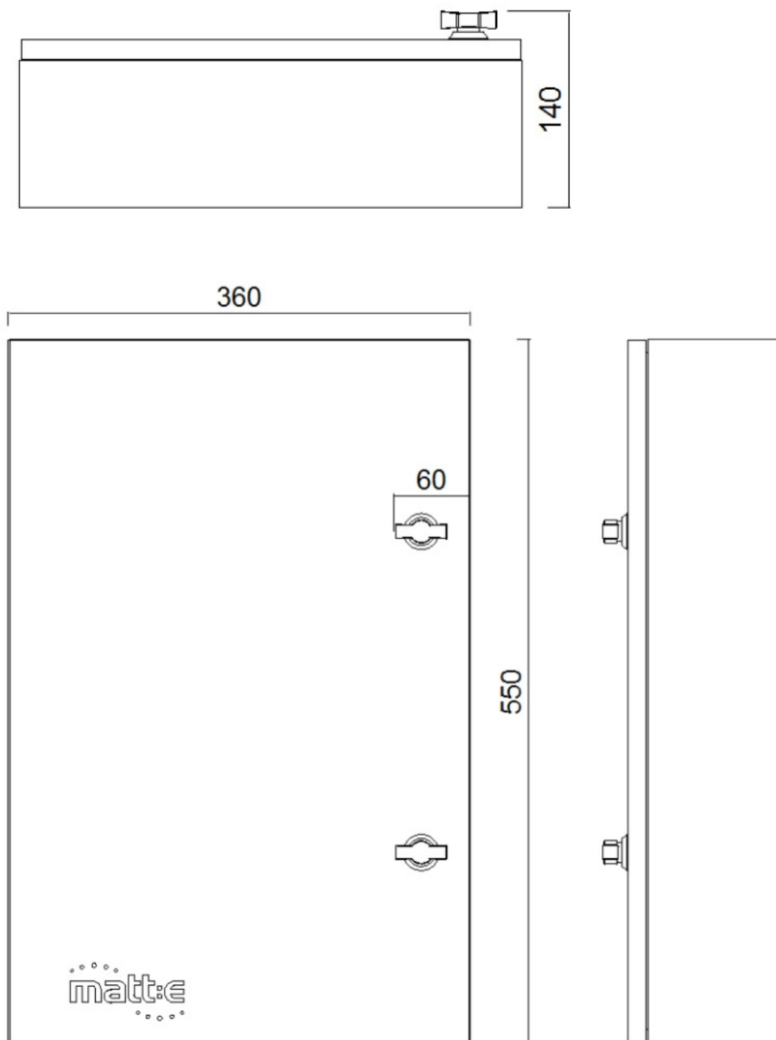

Fixing Positions

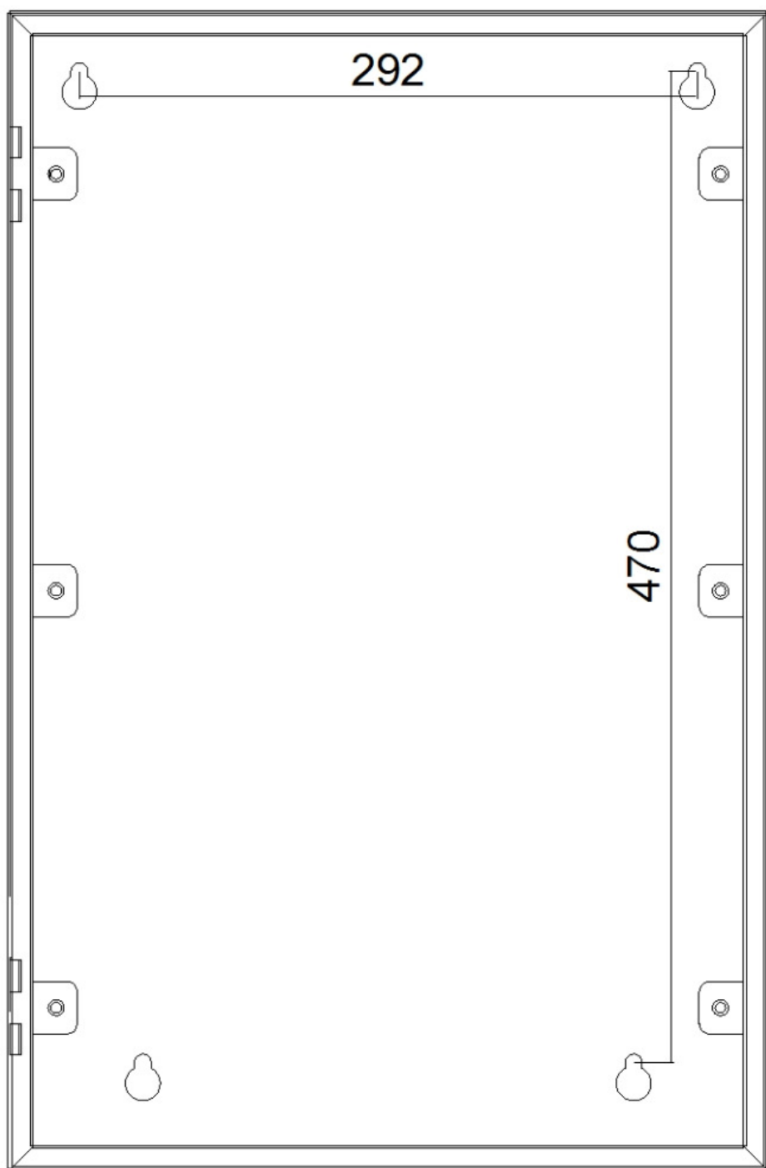

Electrical Connections

The user wiring connections are indicated in the image below.

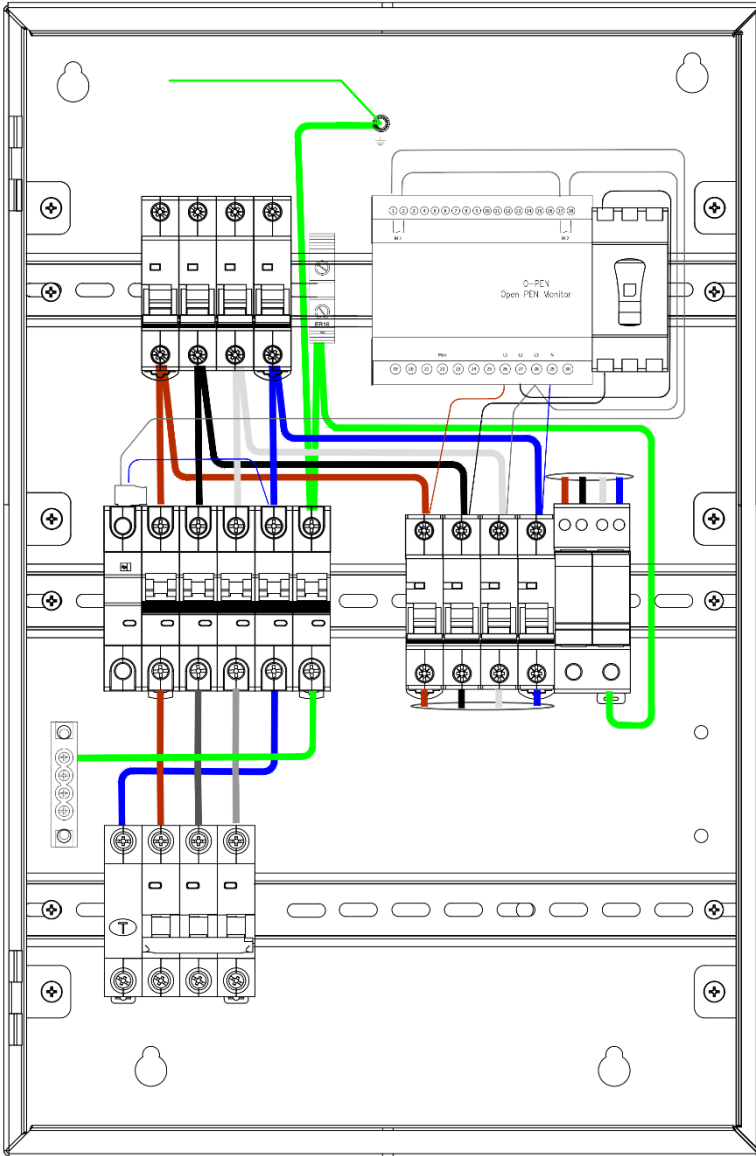

Installation instructions

Connect the incoming cable from the distribution board directly to the 4-pole isolator. The CPC should be connected to the terminal block. Connect the outgoing cable(s) to the RCBO. The outgoing CPC should be connected to the green isolated earth bars.



Electrical
hazard

**THIS PRODUCT IS DESIGNED FOR AN ISOLATED
EARTHING ARRANGEMENT. CHECK BEFORE USING
SWA CABLE**

On completion of installation the tightness of all electrical connections should be checked before energising the unit.

See specifications for tightening torques.

Operating Instructions

With the incoming isolator closed the unit will monitor the incoming supply. If no fault condition is present approximately 1 second after closing the incoming isolator the O-PEN monitor will energise the under-voltage release mechanism of the 5-pole isolator (indicated by the green LED illuminating). At this point the 5-pole isolator can be closed to connect the load to the incoming supply. Alternatively wait 30 seconds and the isolator will automatically close.

In the event the O-PEN unit detects a fault condition on the monitored supply for a period of 4 seconds the internal relays will de-energise and remove the supply to the under-voltage release mechanism of the 5-pole isolator. This will cause the 5-pole isolator to open disconnecting all phases, neutral and CPC from the load.

Once the fault condition has cleared the O-PEN unit will reset after a 3-minute period and the 5-pole isolator will automatically reclose 30 seconds after

Test Function

Test Switch

O = Test

I = Normal

A Test Switch is provided to allow the functionality of the units to be checked. With the unit powered and the 5-pole isolator closed rotate the Test Switch anti-clockwise to position O to initiate a test. This will disconnect L1 from the O-PEN monitor and create a fault condition. After 0.7 seconds the O-PEN monitor will trip the 5-pole isolator by de-energising the under-voltage release mechanism.

We recommend the unit is tested on a 6 monthly basis.

SPD Indicator

The unit has a built in Type 2 surge protection device.



These have an indication window at the top of the device.

This window will turn RED once the device reaches the end of its operational life.

There is not a set time on how long these devices will last as it depends on the amount of surges the devices protects the installation from. matt:e recommends that the SPD is checked a minimum of every 6 months.

If the indicators are showing RED the SPD has reached the end of its operational life and is no longer offering any protection. If this occurs, please seek expert advice.

Specifications

Description	Electric Vehicle Charger Connection Unit
Input (Volts)	Nominal input voltage 400v, 50Hz, 3 Phase AC
Max Load	32A per phase
Dimensions	550mm x 360mm x 120mm
Weight	Approximately 10 kg
Operating Temp	-5°C to +40°C
Enclosure	Mild Steel Powder Coated
Power Consumption	12VA
Ingress Protection	IP4X
Document Revision	V1.10 Mar 2022

Terminal Capacities	<u>Min</u>	<u>Max</u>
Incoming Isolator cable size & tightening torque	2.5 mm ² 1.5Nm	25.0mm ² 2Nm
Outgoing MCB cable size & tightening torque	2.5 mm ² 1.5Nm	25.0mm ² 2Nm
Outgoing RCBO cable size & tightening torque	2.5 mm ² 1.5Nm	25.0mm ² 2Nm

Warranty

The ARD-1-32-TP-R-SPD is guaranteed for a period of 1 year from the date of manufacture.

This warranty is limited to the replacement of faulty components only.

t: 01543 227290 e: info@matt-e.co.uk w: www.matt-e.co.uk

matt:e Ltd, Unit 1 Langley Brook Business Park Middleton Tamworth BS78 2BP

EU Declaration of Conformity (DoC)

Ref: ARDSPD-2023

We

Company name: matt:e Ltd
Postal address: Unit 1 Langley Brook Business Park
City: Middleton, Tamworth
Postcode: B78 2BP
Telephone number: 01543-227290
E-Mail address: info@matt-e.co.uk

Declare that this DoC is issued under the sole responsibility of the manufacturer.

Apparatus model/Product: ARD-1-32-TP-R-SPD
Type: EVCC

Object of the declaration

Electric Vehicle Charger
Connection units

ARD-1-32-TP-R-SPD

The object of the declaration described above is in conformity with the relevant Union harmonisation legislation:

Low Voltage Directive (2014/35/EU)

The following harmonised standards and technical specifications have been applied:

EN60255-1 2010 Emissions standard for Measuring Relays and Protection Equipment
EN55011 Class A 2011 + A1:2017 Emissions Standard for ISM Equipment

EN60255-26 2013 Immunity standard for Measuring Relays and Protection Equipment,
EN61000-4-2 2009 ESD Requirements
EN61000-4-3 2006 + A1 + A2 Radiated Susceptibility
EN61000-4-4 2012 Electrical Fast Transient Burst Requirement
EN61000-4-5 2006 Surges Requirements
EN61000-4-6 2009 Conducted Susceptibility
EN61000-4-11 2004 Voltage Dips and Interruptions

EN61439-1&2 2011 Low-voltage switchgear and control gear assemblies.
EN60947-3 Low-voltage switchgear and control gear
BS EN 61643-11-2012+A11:2018 Low-voltage surge protective devices
EN61095 Electromechanical contactors
EN61009-1 Residual current operated circuit-breakers with integral overcurrent

Signed for and on behalf of: matt:e Ltd

Place of issue
Tamworth, England

Date
Jan 2023



R Winter, Director